

Hierarchical description of Provided CHOs from libraries

Contributor:

Stefanie Rühle, SUB Göttingen and Consortium of European Research Libraries working for the Deutsche Digitale Bibliothek (DDB) Project and the Europeana Libraries Project.

Short note on the projects:

Deutsche Digitale Bibliothek (DDB): The Deutsche Digitale Bibliothek is an online portal funded by the German government, which interlinks data of German cultural heritage and research institutions and provides Europeana with these data.

Europeana Libraries: The goal of the Europeana Libraries project is the development of an aggregation infrastructure that will provide Europeana with metadata of digital collections of European research libraries.

Rev.	Date	Author	Institution	Description
1.0	02.08.2012	Stefanie Rühle	SUB Göttingen and CERL	use cases for hierarchical CHOs
2.0	01.11.2012	Stefanie Rühle	SUB Göttingen and CERL	revision and edm examples
2.1	15.11.2012	Stefanie Rühle	SUB Göttingen and CERL	revision of EDM-Use Case graphs using edm:isNextInSequence (Use Case 4 and 5)
2.2	11.03.2013	Stefanie Rühle	SUB Göttingen and CERL	Final revision of graphs using edm:isNextInSequence

Introduction

Hierarchical or multilevel description

A **multilevel description** is a form of presentation of descriptive data based on the division of descriptive information into two or more levels. The first level contains information pertaining to the resource as a whole. The second and subsequent levels contain information relating to individual parts of the resources. (Source: RDA Draft 2008, App. D 2.4.1)

The relations between the whole resource and its parts are

- the **has-part** relation = top down.
- the **is-part-of** relation = bottom up

In the following diagrams these relations are represented by a \updownarrow

The relations between the parts of a resource are given by the consecutive numbering of the parts or by pagination. The relations are

- the **has-next-in-sequence** relation = from the lower number to the higher number
- the **is-next-in-sequence-of** relation = from the higher number to the lower number

In the following diagrams these relations are represented by a \leftrightarrow

For the description of hierarchical objects some items and relations are mandatory – in the diagrams such **must-be items and relations are indicated by black arrows**. Other items and relations are optional or conditional – in the diagrams such **may-be items and relations are indicated by blue arrows**.

The physical and semantic structures of digital objects

Physical structure

A digital object is composed of different physical units. In case of a born digital this may be a homepage and its different websites, in case of a digitized object it is “e-book” (a former book or booklet) and its “images” (showing the pages). The physical structure relates the pages to the book or booklet and makes sure that they are shown in the correct sequence. This structure is needed for Viewers (as the DFG-Viewer, see <http://dfg-viewer.de/en/regarding-the-project/>) to allow the user to browse through the pages in the correct order. Therefore next to the hierarchical structure of the physical units the horizontal structure of these units (is-next-in-sequence/has-next-in-sequence) has a decisive role for the physical description of digitized objects.

Figure 1: physical structure of a digitized object

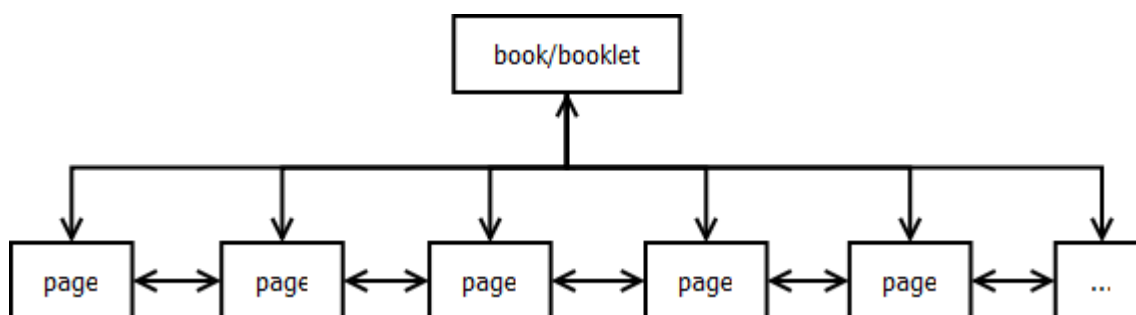

Semantic structure

Next to the physical units most bibliographic objects are also composed of semantic units (e.g. chapter, article, issues, parts, volumes, supplements etc.). Some semantic units are only relevant as part of the whole resource and make sense only in relation to the previous and/or the next unit (e.g. chapters of a book), others are relevant by themselves (e.g. an article or a special issue in a journal). The semantic structure allows the user a hierarchical or horizontal browsing through the bibliographic description of the semantic units.

Figure 2: semantic structure of a digitized object

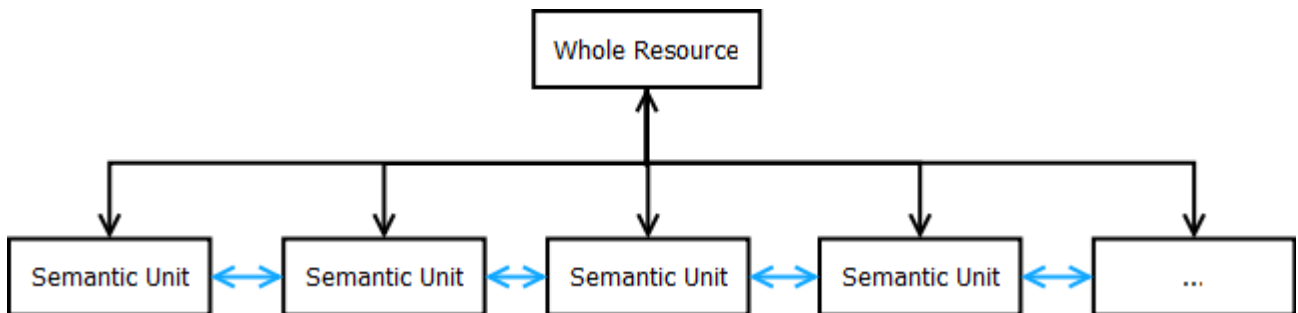

Related physical and semantic structure

Generally the description of digitized bibliographic objects interlinks the semantic unit with the physical units that compose it (e.g. a METS/MODS description uses the mets:structLink element, see <http://gdz.sub.uni-goettingen.de/oai2/?verb=GetRecord&identifier=PPN340040033&metadataPrefix=mets>).

Such Interlinking allows the Viewer to get from the bibliographic description of a semantic unit to the first image of this unit in the physical structure.

Figure 3: semantic structure of a digitized object

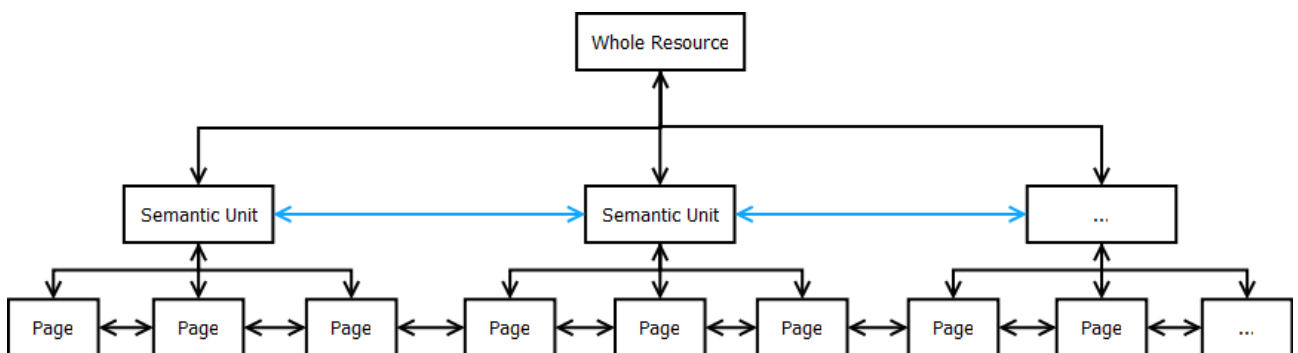

Physical and semantic structures in Europeana

As we have seen above the physical structure is principally needed in the context of a Viewer, which makes it possible to look at the images of a digitized object in the right order. Europeana by

itself does not provide a Viewer for this purpose, but links to the Viewers of the data providers. For this reason it is not necessary to transform the physical structure into EDM. On the other hand a direct link to a semantic unit can only work, if there is a link to the first page of this unit in the context of the viewer. How this link looks like depends on the Viewer the data provider uses and should therefore be created by the data provider himself.

Examples

Monographs

A **monograph** is a resource that is complete in one part or intended to be completed within a finite number of parts. (Source RDA Draft 2008 Glossary)

There are three use cases for monographs:

Use Case 1: Simple Monograph

A simple monograph is a monograph that exists in one volume with chapters that are semantically related to each other.

Figure 4: multilevel description of a monograph

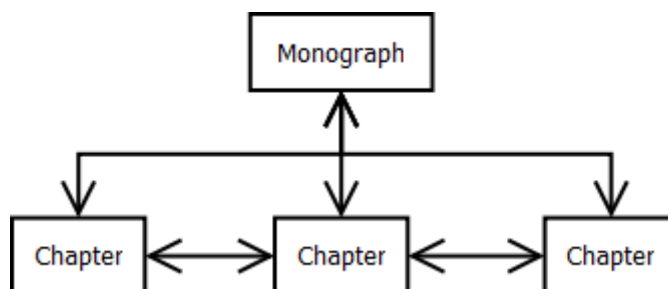

Chapters of a monograph are generally not catalogued separately. In such cases a hierarchical mapping to EDM is not necessary. If chapters are catalogued separately the simple monograph should be treated like an anthology.

The following example is a METS/MODS description of a simple monograph with a web resource that is part of a series without counting.

http://dbs.hab.de/oai/wdb/?verb=GetRecord&metadataPrefix=mets&identifier=oai:diglib.hab.de:ppn_550814205

Transformed to EDM it may look this way:

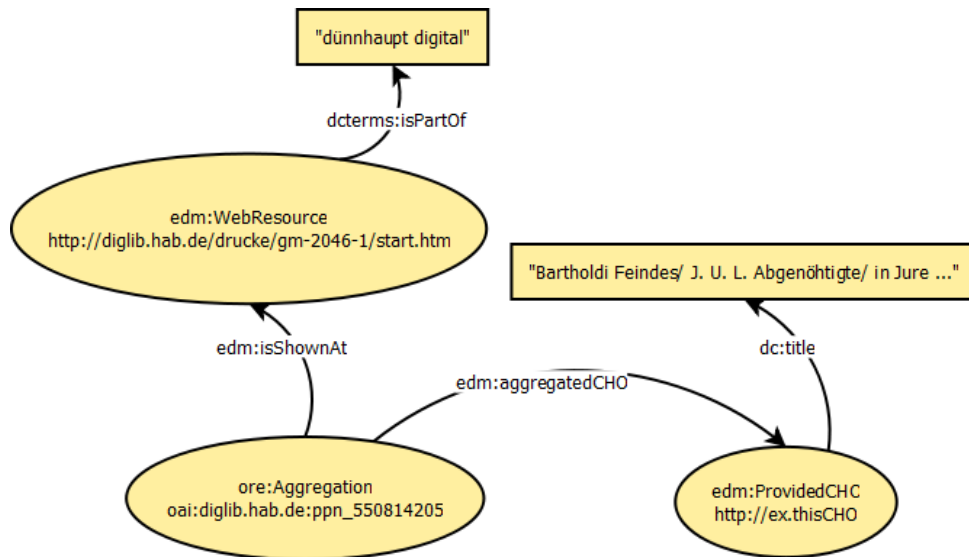

Use Case 2: Anthology

An anthology is a collection of literary works chosen by the compiler. It may be a collection of poems, short stories, plays, songs, etc. (source: <http://en.wikipedia.org/wiki/Anthology>).

Figure 5: multilevel description of anthologies

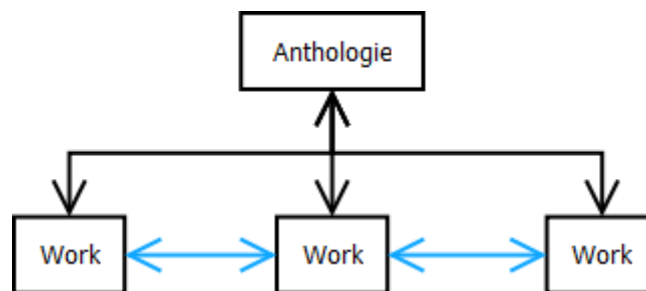

The following example is a METS/MODS description of an anthology and its web <http://dibiki.ub.uni-kiel.de/viewer/metsresolver?id=PPN541730703>

Transformed to EDM it may look this way:

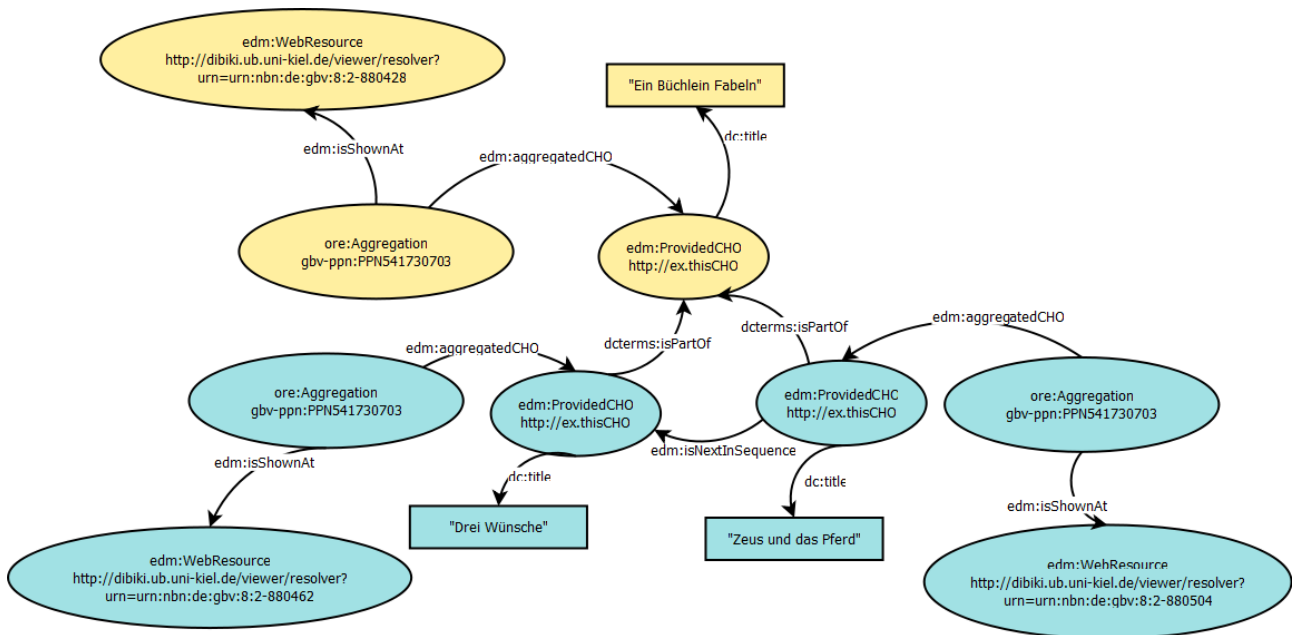

Use Case 3: Multivolume Work

A resource issued in two or more volumes (either simultaneously or successively) that is complete or intended to be completed within a finite number of parts (e.g., a dictionary in two volumes or three audiocassettes issued as a set). (source: RDA Draft 2008, Glossary)

The volume of a multivolume work may consist of one or more parts. If one or more of the volumes are anthologies, they should be treated as such.

Figure 6: multilevel description of multivolume works

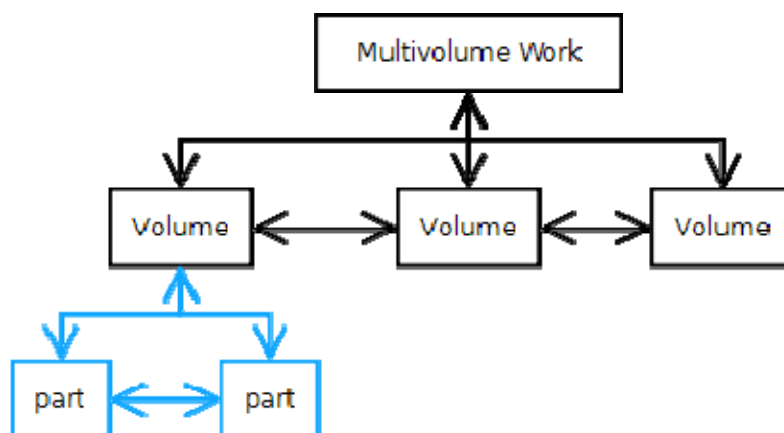

The following example is a METS/MODS description of a multivolume work.

Multivolume Work: http://gdz.sub.uni-goettingen.de/mets_export.php?PPN=PPN590094203

Volume 1: http://gdz.sub.uni-goettingen.de/mets_export.php?PPN=PPN590094319

Volume 2: http://gdz.sub.uni-goettingen.de/mets_export.php?PPN=PPN59009436X

Transformed to EDM it may look this way:

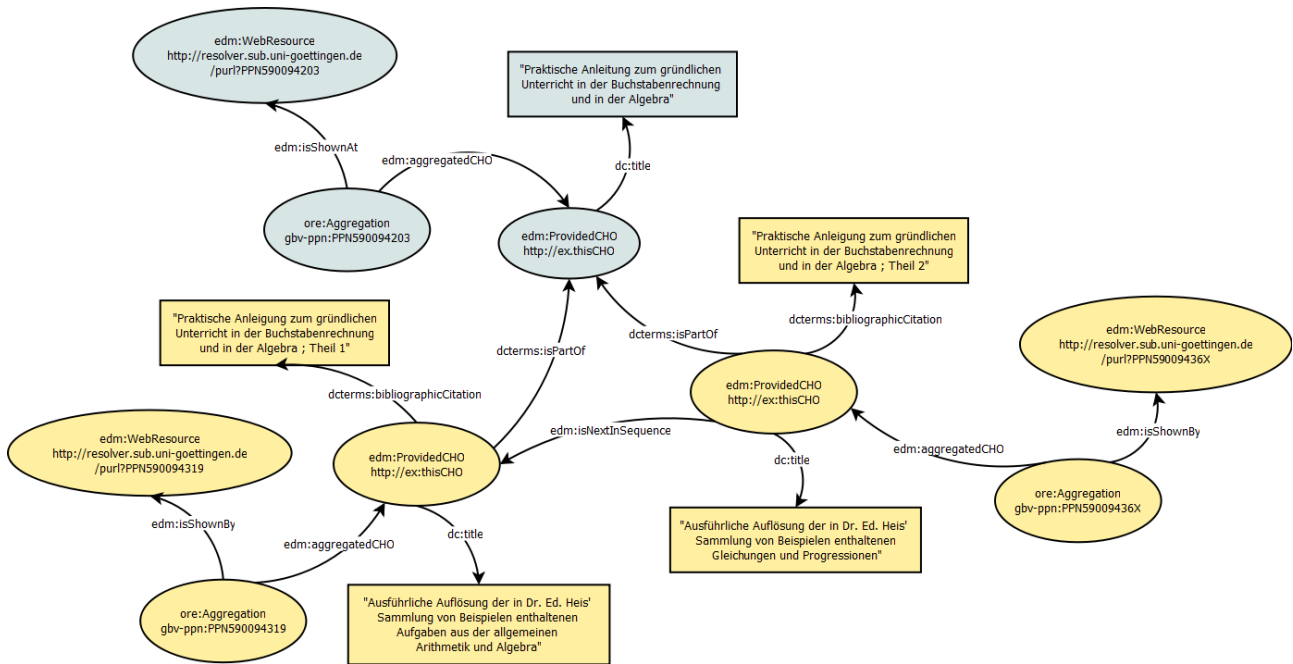

Serials

A **serial** is a resource issued in successive parts that has no predetermined conclusion usually bearing numbering (e.g., a periodical, a monographic series, or a newspaper). Includes resources that exhibit characteristics of serials, such as successive issues, numbering, and frequency, but whose duration is limited (e.g., newsletters of events) and reproductions of serials. (Source: RDA Draft 2008, Glossary)

There are two use cases for serials:

Use Case 4: Series

A group of separate resources related to one another by the fact that each resource bears, in addition to its own title proper, a collective title applying to the group as a whole. The individual resources may or may not be numbered. (Source: RDA Draft 2008, Glossary).

Use Case 4.1: Generally the individual resource is a monograph. Such a monograph could be a multivolume work.

Figure 7: multilevel description of series

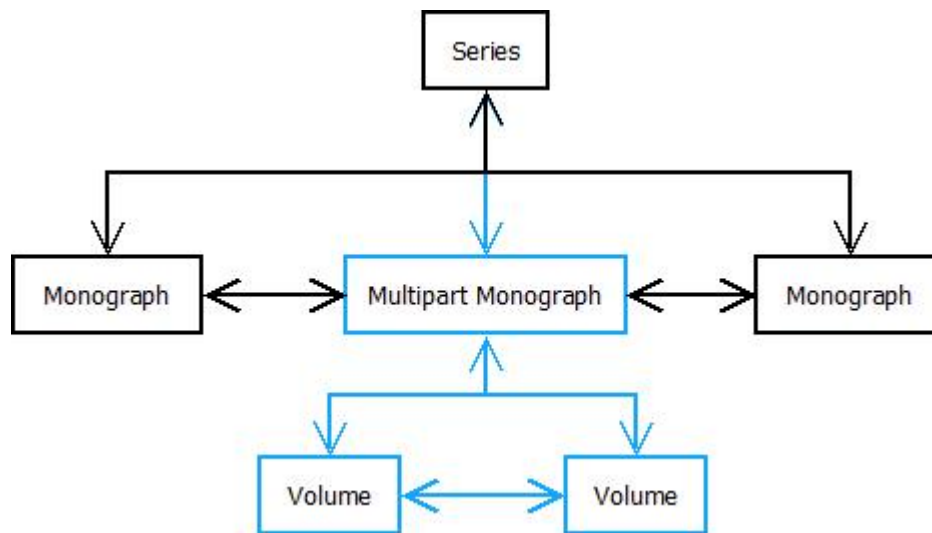

Use Case 4.2: Sometimes an individual resource is part of more than one series.

Figure 8: multilevel description of monographs as part of more than one series

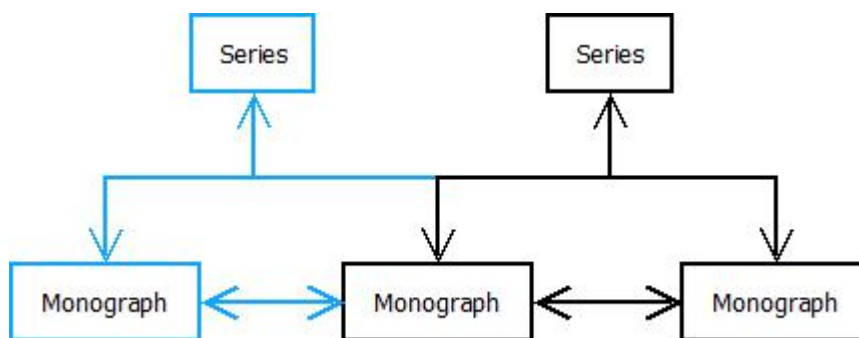

Use Case 4.3: Sometimes an individual resource is part of a series and a multivolume work.

Figure 9: multilevel description of monographs as part of a series and a multivolume work

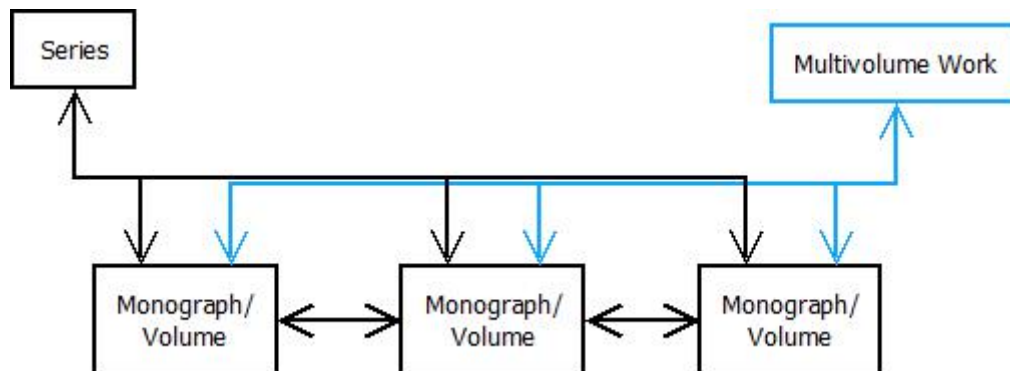

The following example is a catalogue entry for a series.

<http://www.econis.eu/DB=1/SET=1/TTL=240/CMD?ACT=SRCHA&IKT=5041&SRT=YOP&TRM=ruhr+economic+papers>

To go to the different monographs click on “zugehörige Publikationen”.

Transformed to EDM it may look this way

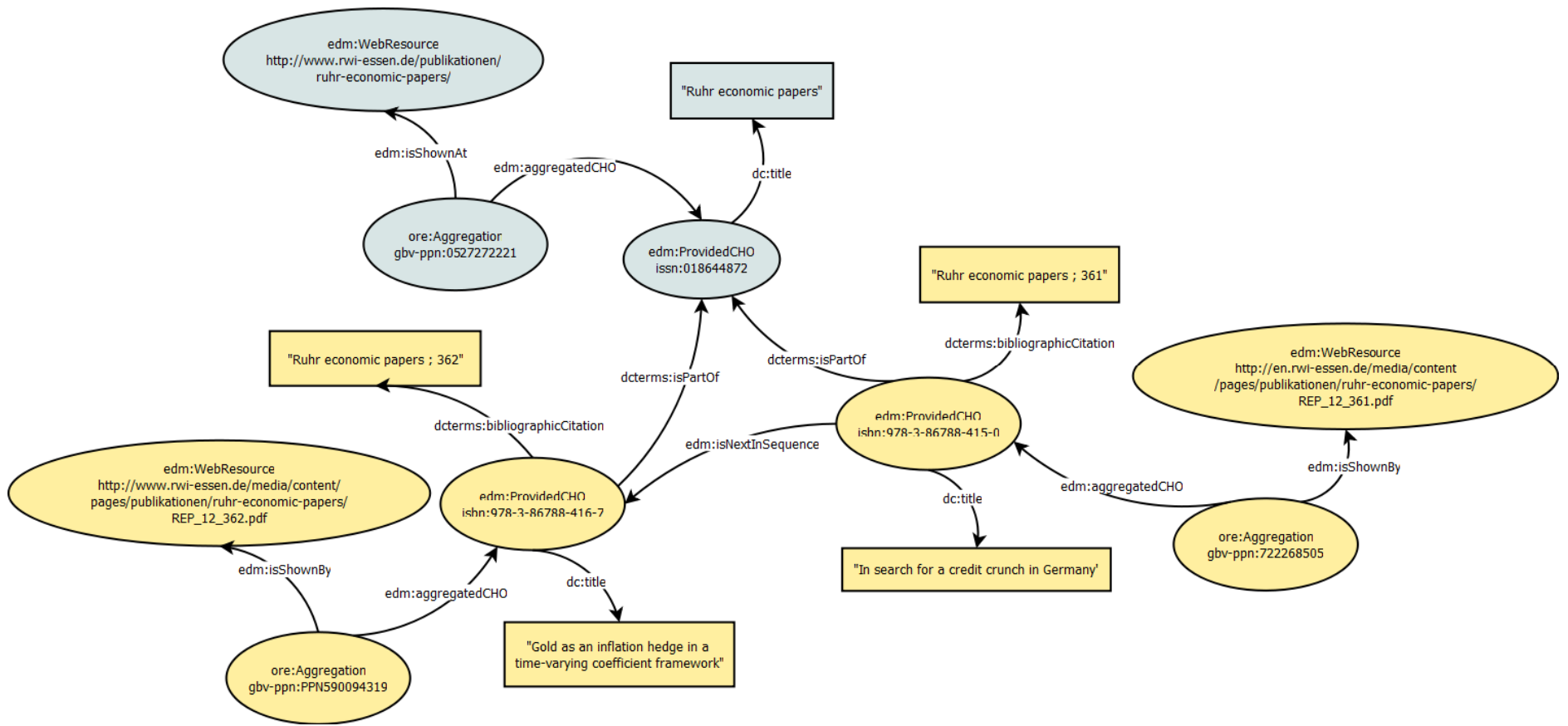

Use Case 5: Periodical

A published work that appears in a new edition on a regular schedule. The most familiar examples are [newspapers](#), often published daily, or weekly; or [magazines](#), typically published weekly, monthly or as a quarterly. Other examples would be a [newsletter](#), a [literary journal](#) or [learned journal](#), or a [yearbook](#). These examples are typically published and referenced by volume and issue. (Source: <http://en.wikipedia.org/wiki/Periodical>)

Use Case 5.1: Generally the relation between an article and a periodical is described via the volume and/or issue levels (often the issue level is not represented in the metadata). But sometimes only the periodical and the article are described and related to each other directly.

Figure 10: multilevel description of periodicals

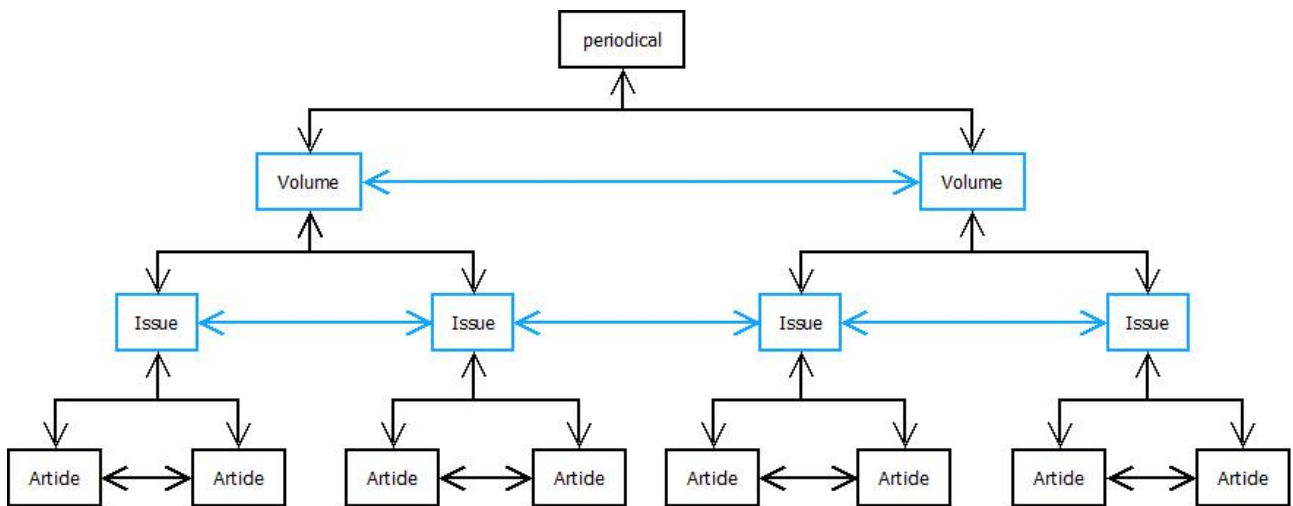

Use Case 5.2: Sometimes an article consists of different parts issued in different issues and/or volumes of the periodical.

Figure 11: multilevel description of periodicals with multipart article

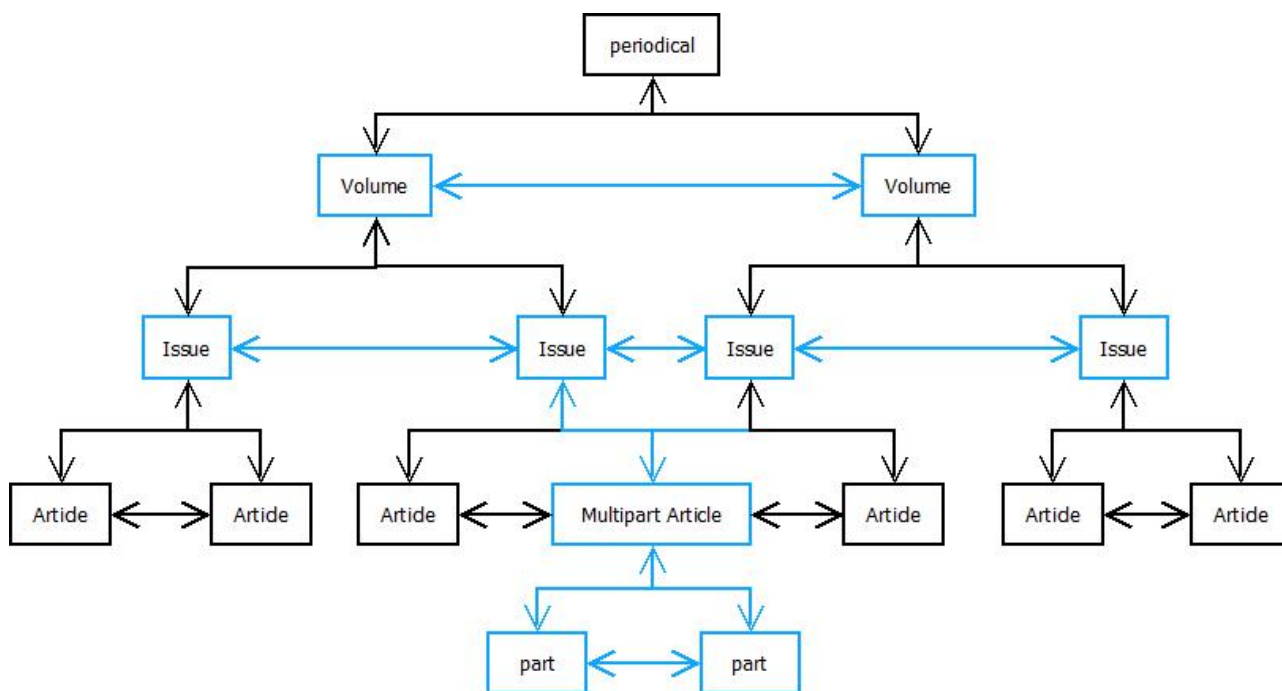

Use Case 5.3: Sometimes an issue is also a part of a series.

Figure 12: multilevel description of a periodical issue that is also part of a series

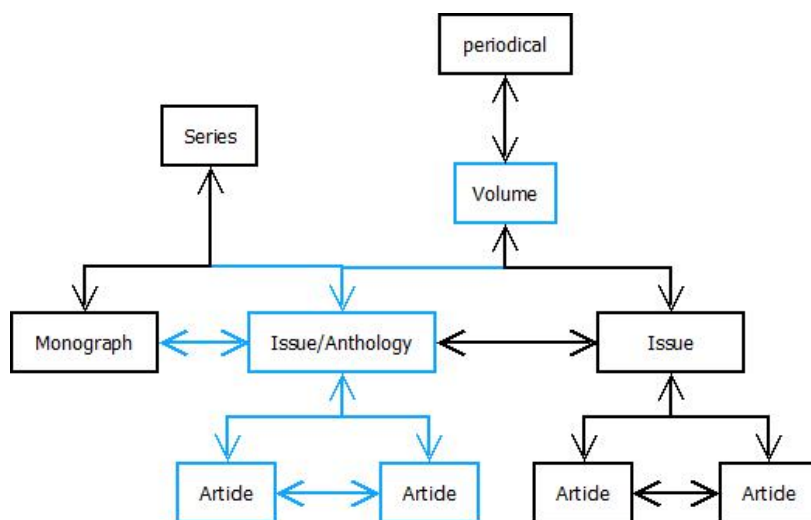

The following example is a METS/MODS description of a journal with a multipart article in issues 1 and 2 of volume 23.

Journal: http://gdz.sub.uni-goettingen.de/mets_export.php?PPN=PPN332924793

Volume 23: http://gdz.sub.uni-goettingen.de/mets_export.php?PPN=PPN332924793_0023

Volume 24: http://gdz.sub.uni-goettingen.de/mets_export.php?PPN=PPN332924793_0024

Transformed to EDM it may look this way:

